

ANKER FLEXCO

TRANSPORTBAND-VERBINDUNGSSYSTEME
CONVEYOR BELT FASTENING SYSTEMS
SYSTÈMES D'AGRAFAGE POUR BANDES TRANSPORTEUSES



Programmübersicht
Alligator/Flexco/Tatch A Cleat



Program Overview
Alligator/Flexco/Tatch A Cleat

Gamme de produits
Alligator/Flexco/Tatch A Cleat

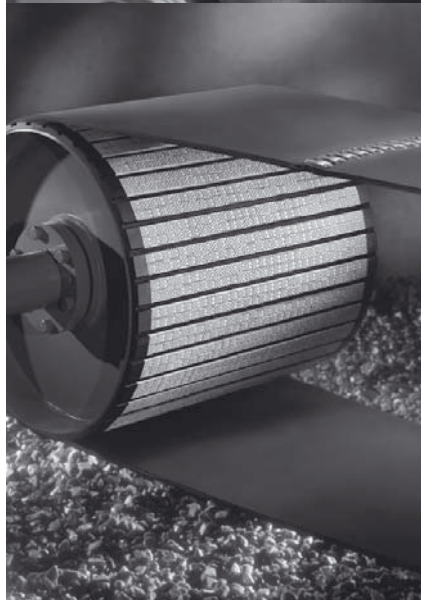

ALLIGATOR Lacing

Transportband - Verbindungssystem für Bandstärken bis 11 mm
 Conveyor Belt Fastening System for Belts up to 11 mm thick
 Système d'agrafage pour bandes transporteuses jusqu'à d'épaisseur 11 mm 4

ALLIGATOR Ready Set

Transportband - Verbindungssystem für Bandstärken von 1,5 bis 6,4 mm
 Conveyor Belt Fastening System for Belts 1,5 to 6,4 mm thick
 Système d'agrafage pour bandes transporteuses d'épaisseur 1,5 - 6,4 mm 6

ALLIGATOR Plastic Rivet

Plastikverbinder für Bandstärken von 1,6 - 3,2 mm
 Plastic Rivet Fasteners for Belts 1,6 - 3,2 mm thick
 Agrafes plastiques pour bandes transporteuses d'épaisseur 1,6 - 3,2 mm 9

ALLIGATOR Rivet

Transportband - Verbindungssystem für Rundballenpressen
 Conveyor Belt Fastening System for Round Balers
 Système d'agrafage pour bandes transporteuses pour presses à balles 10

FLEXCO Rivet Solid Plate

Transportband - Verbindungssystem für Bandstärken von 6 bis 24 mm
 Conveyor Belt Fastening System for Belts 6 to 24 mm thick
 Système d'agrafage pour bandes transporteuses d'épaisseur 6 - 24 mm 11

FLEXCO Rivet Hinged

Transportband - Verbindungssystem für Bandstärken von 5 bis 17 mm
 Conveyor Belt Fastening System for Belts 5 to 17 mm thick
 Système d'agrafage pour bandes transporteuses d'épaisseur 5 - 17 mm 12

FLEXCO Bolt Hinged

Transportband - Verbindungssystem für Bandstärken von 6 bis 16 mm
 Conveyor Belt Fastening System for Belts 6 to 16 mm thick
 Système d'agrafage pour bandes transporteuses d'épaisseur 6 - 16 mm 18

FLEXCO Bolt Solid Plate

Transportband - Verbindungssystem für Bandstärken von 5 bis 30 mm
 Conveyor Belt Fastening System for Belts 5 to 30 mm thick
 Système d'agrafage pour bandes transporteuses d'épaisseur 5 - 30 mm 20

FLEXCO Bolt Hinged / Bolt Solid Plate

Extra Schrauben und Muttern
 Extra Bolts and Nuts
 Vis et écrous supplémentaires. 23

ALLIGATOR/FLEXCO

Bandschneider und Zubehör
 Belt Cutters and Accessories
 Coupeuses de bande et accessoires. 24

Rockline / Mineline / Eliminator

Bandabstreifer
 Belt Cleaners
 Racleurs de bande. 27

TATCH A CLEAT

Schraubstollen und Führungsprofile
 Mechanical Belt Cleats and Guides
 Profils à vis et de guidage 30

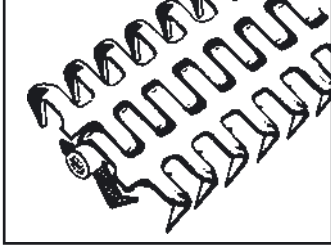

ALLIGATOR Lacing

Transportband -
Verbindungssystem für
Bandstärken bis 11 mm

Conveyor Belt Fastening
System for Belts up to
11 mm thick

Système d'agrafage pour
bandes transporteuses
jusqu'à d'épaisseur 11 mm

Verbindergroße Fastener Size Taille des agrafes	empf. Bandstärkenbereich Belt Thickness Range Épaisseur de bandes recommandée mm	empf. kleinster Trommel-Ø rec. min. Pulley-Ø Ø tambour mini.rec. mm
00	- 1,6	25
1	1,6 - 2,4	40
7	2,4 - 3,6	50
15	3,2 - 4,0	65
20	4,0 - 4,8	75

Verbindergroße Fastener Size Taille des agrafes	empf. Bandstärkenbereich Belt Thickness Range Épaisseur de bandes recommandée mm	empf. kleinster Trommel-Ø rec. min. Pulley-Ø Ø tambour mini.rec. mm
25	4,8 - 5,6	100
27	5,6 - 7,1	125
35	7,1 - 7,9	175
45	7,9 - 9,5	230
55	9,5 - 11,0	300

Inhalt: Jeder Karton enthält 4
komplette Verbindungen für
die angegebene Bandbreite.

Content: Each Box contains 4
Sets Lacing for the Belt Width
specified.

Contenu: Chaque boîte contient 4
jeux complets de jonction pour la
largeur de bande spécifiée.

Stahl / Steel / Acier

Bestell-Nr. Order-No. No. de réf.	Bandbreite Belt Width Larg. de bande mm	Gewicht Weight Poids kg
00 (4 Verbindersets / Fastener Sets / Jeux de jonction)		
00-300	300	0,14
00-600	600	0,28
00-900	900	0,42
00-1200	1200	0,57
1A		
1A-300	300	0,25
1A-600	600	0,49
1A-900	900	0,73
1A-1000	1000	0,82
1A-1200	1200	0,98
1A-1500	1500	1,22
7		
7-300	300	0,32
7-600	600	0,64
7-900	900	0,96
7-1000	1000	1,07
7-1200	1200	1,28
7-1500	1500	1,61
15		
15-300	300	0,46
15-600	600	0,91
15-900	900	1,37
15-1200	1200	1,83
20		
20-300	300	0,60
20-600	600	1,20
20-900	900	1,81
20-1200	1200	2,42

Stahl / Steel / Acier

Bestell-Nr. Order-No. No. de réf.	Bandbreite Belt Width Larg. de bande mm	Gewicht Weight Poids kg
25 (4 Verbindersets / Fastener Sets / Jeux de jonction)		
25-300	300	0,68
25-600	600	1,35
25-900	900	2,03
25-1200	1200	2,70
27		
27-300	300	0,80
27-600	600	1,60
27-900	900	2,38
27-1200	1200	3,18
35		
35-300	300	1,28
35-600	600	1,60
35-900	900	3,84
35-1200	1200	5,12
45		
45-300	300	1,51
45-600	600	3,17
45-900	900	4,75
45-1200	1200	6,34
55		
55-300	300	2,17
55-600	600	4,34
55-900	900	6,34
55-1200	1200	8,70

Rostfrei / Stainless / Inoxydable

Bestell-Nr. Order-No. No. de réf.	Bandbreite Belt Width Larg. de bande mm	Gewicht Weight Poids kg
---	--	----------------------------------

00S (4 Verbindersets / Fastener Sets / Jeux de jonction)

00S-300	300	0,14
00S-600	600	0,28
00S-900	900	0,42
00S-1200	1200	0,57

1S

1S-300	300	0,25
1S-600	600	0,49
1S-900	900	0,73
1S-1000	1000	0,82
1S-1200	1200	0,98
1S-1500	1500	1,22

Gelenkriemen- verbinder

Transmission Belt Lacing

Stahl / Steel / Acier

Bestell-Nr. Order-No. No. de réf.	Verbinder Sets Fastener Sets Jeux de jonction	Gewicht Weight Poids kg
---	---	----------------------------------

00	6 X 150	0,09
1A	6 X 150	0,15
7	6 X 150	0,20
15	8 X 300	0,41
20	8 X 300	0,55
25D	8 X 300	0,64
27K	8 X 300	0,78
35N	8 X 300	1,23
45U	8 X 300	1,50
55W	8 X 300	2,14
65X	8 X 300	2,63

Eco Pack

Jede VPE enthält 10 Verbindersets, einzeln verpackt.

Each package contains 10 sets of lacing, individually packed.

Chaque unité d'emballage comprend 10 jeux de jonction, emballés individuellement.

Bestell-Nr. Order-No. No. de réf.	Verbinder Sets Fastener Sets Jeux de jonction	Gewicht Weight Poids kg
---	---	----------------------------------

15E	10 X 300	0,41
20E	10 X 300	0,55
25E	10 X 300	0,64
27E	10 X 300	0,78
35E	10 X 300	1,23

Rostfrei / Stainless / Inoxydable

Bestell-Nr. Order-No. No. de réf.	Bandbreite Belt Width Larg. de bande mm	Gewicht Weight Poids kg
---	--	----------------------------------

7S

7S-300	300	0,32
7S-600	600	0,64
7S-900	900	0,96
7S-1000	1000	1,07
7S-1200	1200	1,28
7S-1500	1500	1,61

Agrafes flexibles pour courroies de transmission

Rostfrei / Stainless / Inoxydable

Bestell-Nr. Order-No. No. de réf.	Verbinder Sets Fastener Sets Jeux de jonction	Gewicht Weight Poids kg
---	---	----------------------------------

00S	6 X 150	0,09
1AS	6 X 150	0,15
7S	6 X 150	0,20
15S	8 X 300	0,41
20S	8 X 300	0,55
25DS	8 X 300	0,64
27KS	8 X 300	0,78
35NS	8 X 300	1,23
45US	8 X 300	1,50
55WS	8 X 300	2,14



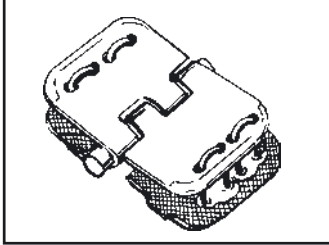

ALLIGATOR Ready Set

Transportband-
Verbindungssystem für
Bandstärken von
1,5 - 6,4 mm

Conveyor Belt Fastening
System for Belts 1,5 - 6,4
mm thick

Système d'agrafage pour
bandes transporteuses
d'épaisseur 1,5 - 6,4 mm

Verbindergroße Fastener Size Taille des agrafes	Für Transportbänder bis zu... N/mm Festigkeit For Belts with a Tensile Strength of up to... N/mm Pour bandes tranporteuses à résistance de rupture jusqu'à... N/mm	empf. Bandstärkenbereich Belt Thickness Range Épaisseur de bandes recommandée mm	empf. kleinster Trommel-Ø rec. min. Pulley-Ø Ø tambour mini.rec. mm
RS62	200	1,5 - 3,2	50
RS125	315	3,2 - 4,8	75
RS187	400	4,8 - 6,4	100

Inhalt: Jeder J-Karton enthält 4
komplette Verbindungen für
die angegebene Bandbreite.

Content: Each J-box contains 4
Sets Lacing for the Belt Width
specified.

Contenu: Chaque boîte J contient
4 jeux complets de jonction
pour la largeur de bande spécifiée.

Stahl verzinkt Galvanized Steel / Acier galvanisé

Bestell-Nr. Order-No. No. de réf.	Bandbreite Belt Width Larg. de bande mm	Gewicht Weight Poids kg
RS62J12/300NC	300	0,61
RS62J24/600NC	600	1,22
RS62J32/800NC	800	1,64
RS62J40/1000NC	1000	2,05
RS62J47/1200NC	1200	2,44
RS62J59/1500NC	1500	3,05
RS125J12/300NC	300	0,91
RS125J24/600NC	600	1,78
RS125J32/800NC	800	2,43
RS125J40/1000NC	1000	3,04
RS125J47/1200NC	1200	3,65
RS125J59/1500NC	1500	4,56
RS187J12/300NC	300	1,16
RS187J24/600NC	600	2,69
RS187J32/800NC	800	3,36
RS187J40/1000NC	1000	4,20
RS187J47/1200NC	1200	5,33
RS187J59/1500NC	1500	6,26

Rostfrei Stainless / Inoxydable

Bestell-Nr. Order-No. No. de réf.	Bandbreite Belt Width Larg. de bande mm	Gewicht Weight Poids kg
RS62SJ12/300NCS	300	0,61
RS62SJ24/600NCS	600	1,22
RS62SJ32/800NCS	800	1,64
RS62SJ40/1000NCS	1000	2,05
RS62SJ47/1200NCS	1200	2,44
RS62SJ59/1500NCS	1500	3,05
RS125SJ12/300NCS	300	0,91
RS125SJ24/600NCS	600	1,78
RS125SJ32/800NCS	800	2,43
RS125SJ40/1000NCS	1000	3,04
RS125SJ47/1200NCS	1200	3,65
RS125SJ59/1500NCS	1500	4,56
RS187SJ12/300NCS	300	1,16
RS187SJ24/600NCS	600	2,69
RS187SJ32/800NCS	800	3,36
RS187SJ40/1000NCS	1000	4,20
RS187SJ47/1200NCS	1200	5,33
RS187SJ59/1500NCS	1500	6,26

25 Verbindersets (ohne Kupplungsstäbe) · 25 Fastener Sets (without Hinge Pins) · 25 Jeux de jonction (sans axe)

RS62-47/1200-25	1200	13,50	RS62S-47/1200-25	1200	13,50
RS125-47/1200-25	1200	18,70	RS125S-47/1200-25	1200	18,70
RS187-47/1200-25	1200	27,50	RS187S-47/1200-25	1200	27,50

MegAlloy

Bestell-Nr. Order-No. No. de réf.	Inhalt Content Contenu	Gewicht Weight Poids kg
125MA	8 X 300 mm	1,9
187MA	8 X 300 mm	2,6

Extra Klammern, rostfrei · Extra Staples, stainless Crampons supplémentaires, inoxydables

Bestell-Nr. Order-No. No. de réf.	Verbindergroße Fastener size Taille d'agrafe	Inhalt Content Contenu	Gewicht Weight Poids kg
S125	125	990	0,41
S187	187	990	0,46

Kupplungsdrähte Hinge Material Axes de jonction	Bestell-Nr. Order-No. No. de réf.	Ø mm	Verbindergröße Fastener Size Taille d'agrafe	Inhalt Content Contenu	Gewicht Weight Poids kg	
NC	NC62-X	2,0	RS62	3 m	0,05	
	NC62-C			30 m	0,45	
	NC1-X	3,6	RS125	3 m	0,09	
	NC1-C			30 m	0,77	
	NC187-X	5,2	RS187	3 m	0,09	
	NC187-C			30 m	2,17	
NCS	NCS62-X	2,0	RS62	3 m	0,05	
	NCS62-C			30 m	0,45	
	NCS1-X	3,6	RS125	3 m	0,09	
	NCS1-C			30 m	0,77	
	NCS187-X	5,2	RS187	3 m	0,09	
	NCS187-C			30 m	2,17	
SP * Bandbreite (mm) * Belt Width (mm) * Largeur de bande (mm)	SP62-1000	2,0	RS62	10 X 1000* mm	0,32	
	SP62-1200			10 X 1200* mm	0,37	
	SP62-1500			10 X 1500* mm	0,40	
	SP1-1000	3,6	RS125	10 X 1000* mm	0,68	
	SP1-1200			10 X 1200* mm	0,87	
	SP1-1500			10 X 1500* mm	1,00	
	SP2-1000	4,7	RS187	10 X 1000* mm	1,23	
	SP2-1200			10 X 1200* mm	1,55	
	SP2-1500			10 X 1500* mm	1,80	
	SS * Bandbreite (mm) * Belt Width (mm) * Largeur de bande (mm)	SS62-1000	2,0	RS62	10 X 1000* mm	0,32
		SS62-1200			10 X 1200* mm	0,37
		SS62-1500			10 X 1500* mm	0,42
SS1-1000		3,6	RS125	10 X 1000* mm	0,68	
SS1-1200				10 X 1200* mm	0,87	
SS1-1500				10 X 1500* mm	1,00	
SS2-1000		4,7	RS187	10 X 1000* mm	1,23	
SS2-1200				10 X 1200* mm	1,55	
SS2-1500				10 X 1500* mm	1,95	
Kupplungsstab-Sicherungs- scheiben		62-RET-50		RS62	50	0,04
		125-RET-50		RS125	50	0,05
Hinge Pin Retaining Washers		187-RET-50		RS187	50	0,06
Rondelles de butée pour axes de jonction	310-RET-50		375X/550/R2/R5	50	0,15	
Kupplungsstab-Bieger Pin Bender Outil à plier l'axe de jonction	PB1				0,5	

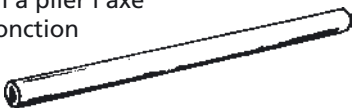

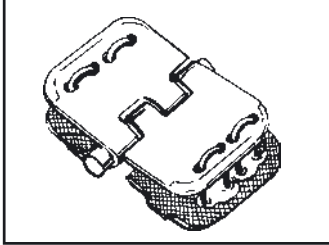

ALLIGATOR Ready Set

Montagewerkzeuge und
Zubehör

Installation Tools and
Accessories

Outillage de montage et
accessoires

RSTK-Werkzeugkoffer

mit RSC187-Gerät, Klammersetzplatte,
Hammer, Rillenhebel, Bandedcken-
trimmzange.

RSTK-Staple Kit

with RSC187 Installation Tool, Staple
Set Plate, Hammer, Hand Skiver,
Belt Nippers.

RSTK-Coffret d'outillage

avec appareil de montage RSC187,
plaque de pose de crampons, marteau,
rabot pour courroie, pince à rogner.

Bestell-Nr.
Order-No.
No. de réf.

Gerät
Tool
Outil

Gewicht
Weight
Poids
kg

RSTK4-6
RSTK4-12

RSC187-6
RSC187-12

8,8
12,1

Bestell-Nr.
Order-No.
No. de réf.

Breite
Width
Largeur
mm

Gewicht
Weight
Poids
kg

Montagegeräte Staple Driving Tools Appareils de montage

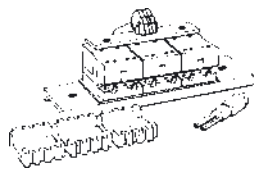

RSC187
RSC187-4
RSC187-6
RSC187-12
RSC187-18
RSC187-24
RSC187-36
RSC187-48
RSC187-60

50
100
150
300
450
600
900
1200
1500

0,5
1,5
3,0
5,0
7,5
9,0
14,0
17,0
25,0

GOLD CLASS Montagegerät GOLD CLASS Installation Tool GOLD CLASS Appareil de montage



RS-GOLD-DRIVER
RS-GOLD-INITIAL-12/300
RS-GOLD-INITIAL-24/600
RS-GOLD-INITIAL-36/900
RS-GOLD-INITIAL-48/1200
RS-GOLD-FINAL-12/300
RS-GOLD-FINAL-24/600
RS-GOLD-FINAL-36/900
RS-GOLD-FINAL-48/1200

5,6
4,8
9,0
11,5
13,6
4,9
9,9
12,3
14,5

Pressbacken für hydraulische Maschinen

Press Plates for Hydraulic Lacers

Mâchoires pour agrafeuses hydrauliques

Für / for / pour

P2AS
P6AS

ARU 2000/3000
AMK 400 / AMU 4000/6000

3,0
5,0

Ersatzteile Spare Parts Pièces de rechange

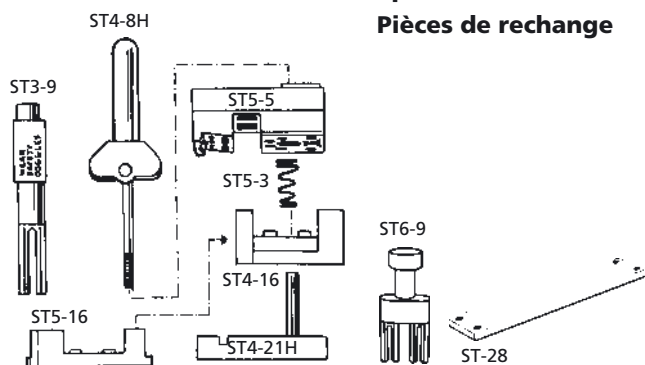

ST5-3 Druckfeder / Spring / Ressort de pression
ST3-9 Klammertreiber / Staple Driver / Chassoir de crampons
ST6-9 Klammertreiber / Staple Driver / Chassoir de crampons
ST4-8H Nockenhebel komplett / Cam Lever Assembly / Levier de tension complet (> RSC187-6)
ST4-16 Kamm grün / Comb green / Peigne vert (125/187)
ST5-16 Kamm gelb / Comb yellow / Peigne jaune (62/125)
ST5-5 Führungsblock / Guide Block / Bloc de guidage
ST-28 Klammersetzplatte / Staple Set Plate / Plaque de pose de crampons
ST3-13 Schraube / Bolt / Vis
ST3-14 Fixierstift / Cam Locating Pin / Goupille
ST3-15-6 Klemmschiene / Clamp Bar / Rail de serrage
ST4-21H Amboßsegment / Anvil / Segment d'enclume
ST7-5 Block schwarz / Guide Block black / Bloc de guidage noir
ST7-9 Stößel / Punch / Poinçon
ST7-29 Setzplatte / Wear Plate / Plaque de pose

ALLIGATOR Plastic Rivet

Plastikverbinder
für Bandstärken
von 1,6 - 3,2 mm

Plastic Rivet Fasteners
for Belts
1,6 - 3,2 mm thick

Agrafes plastiques pour
bandes transporteuses
d'épaisseur 1,6 - 3,2 mm

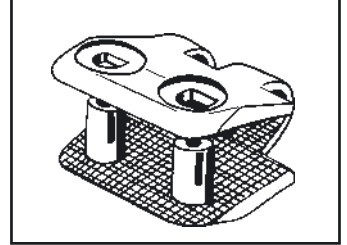

Verbindergröße Fastener Size Taille des agrafes	Für Transportbänder bis zu... N/mm Festigkeit For Belts with a Tensile Strength of up to... N/mm Pour bandes tranporteuses à résistance de rupture jusqu'à... N/mm	empf. Bandstärkenbereich Belt Thickness Range Épaisseur de bandes recommandée mm	empf. kleinster Trommel-Ø rec. min. Pulley-Ø Ø tambour mini.rec. mm
APF100	75	-2,4	40
APF150	100	1,6 - 3,2	75

Plastikverbinder · Non metallic Fasteners · Agrafes plastiques

Bestell-Nr. Order-No. No. de réf.	Inhalt Content Contenu	Gewicht Weight Poids kg	Bestell-Nr. Order-No. No. de réf.	Inhalt Content Contenu	Gewicht Weight Poids kg
APF 100W-100*	100	0,29	APF 150W-100*	100	0,45
APF 100W-500**	500	0,61	APF 150W-500**	500	0,97
APF 100B-100*	100	0,29	APF 150B-100*	100	0,45
APF 100B-500**	500	0,61	APF 150B-500**	500	0,97

* für Bandbreite 1200 mm mit Kupplungsdraht
* for belt width of 1200 mm with hinge material
* pour une épaisseur de bande de 1200 mm avec axe de jonction

** ausreichend für 6 m Verbindung ohne Kupplungsdraht
** sufficient for 6 m splice without hinge material
** suffit pour 6 m de jonction sans axe de jonction

Kupplungsdrähte · Hinge Material · Axes de jonction

Bestell-Nr. Order-No. No. de réf.	Länge Length Longueur m	Gewicht Weight Poids kg	Bestell-Nr. Order-No. No. de réf.	Länge Length Longueur m	Gewicht Weight Poids kg
NK2,50	30	0,20	NK3,50	30	0,40

Montagegerät und Zubehör · Installation Tool and Accessories · Outillage de montage et accessoires

Bestell-Nr. Order-No. No. de réf.	Gewicht Weight Poids kg	Bestell-Nr. Order-No. No. de réf.	Gewicht Weight Poids kg
MDT220-1	15,90	PRL4	0,17
PCA7-600	4,08		

Bohrschablonen · Templets · Gabarits

100T-600	0,63	150T-600	0,57
100T-1200	1,13	150T-1200	1,08

Locheisen · Belt Punch · Poinçon

A100P	0,03	A150P	0,03
--------------	------	--------------	------

Nietkopf · Curling Bit · Tête de pose

S100B	0,03	S150B	0,03
--------------	------	--------------	------

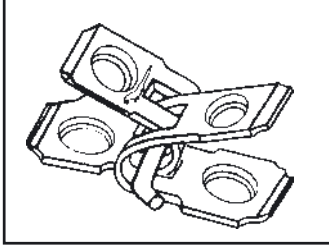

ALLIGATOR Rivet

Transportband-
Verbindungssystem für
Rundballenpressen

Conveyor Belt Fastening
System for Round Balers

Système d'agrafage pour
bandes transporteuses
pour presses à balles

Verbindergröße Fastener Size Taille des agrafes	Für Transportbänder bis zu... N/mm Festigkeit For Belts with a Tensile Strength of up to... N/mm Pour bandes tranporteuses à résistance de rupture jusqu'à... N/mm	empf. Bandstärkenbereich Belt Thickness Range Épaisseur de bandes recommandée mm	empf. kleinster Trommel-Ø rec. min. Pulley-Ø Ø tambour mini.rec. mm
AR	500	3,2 - 5,6	90

Verbinder · Fasteners · Agrafes

Bestell-Nr. Order-No. No. de réf.	Bandbreite Belt Width Larg. de bande mm	Verbindungen Fastener Sets Jeux d'agrafes
ARJ4/100	100	2
ARJ6/150	150	2
ARJ7/175	175	2
ARJ7/175-6STS	175	6
ARJ10/250	250	2
ARJ14/350	350	2



Extra Kupplungsstäbe und Nieten Extra Hinge Pins and Rivets Axes et rivets supplémentaires

Bestell-Nr. Order-No. No. de réf.	Bandbreite Belt Width Larg. de bande mm	Inhalt Content Contenu
gehärteter Stahl, gerillt/steel corrugated, heat-treated/acier rainuré, trempé		
ARSH4/100	100	9
ARSH6/150	150	8
ARSH7/175	175	8
ARSH10/250	250	4
ARSH14/350	350	4
AR3-15	Nieten/Rivets	15

Geräte · Tools · Outils

Bestell-Nr. Order-No. No. de réf.	Gerätebreite Tool Width Largeur d'outil mm
ART-7	175
ART-10	250
ART-14	350



ARTK-Gerätekofter

mit ART-Gerät, Rillenhobel, Hammer, Kupplungsstababbieger und 2 Kartons ARJ-Verbindersets in einem Plastikkoffer

ARTK-Toolkit

includes ART Installation Tool, Hand Belt Skiver, Hammer, Pin Bender and 2 packages of ARJ fasteners in a plastic tool box

Coffret ARTK

Contenu: outil de pose, rabot pour courroie, marteau, outil pour plier les axes et 2 cartons de jeux d'agrafes ARJ dans un coffret plastique

Bestell-Nr. Order-No. No. de réf.	Gerätebreite Tool Width Largeur d'outil mm
ARTK-7	175
ARTK-14	350



FLEXCO Rivet Solid Plate

Transportband -
Verbindungssystem für
Bandstärken
von 6 bis 24 mm

Conveyor Belt Fastening
System for Belts
6 to 24 mm thick

Système d'agrafage pour
bandes transporteuses
d'épaisseur 6 - 24 mm

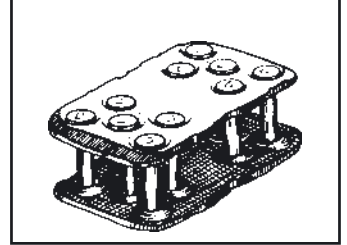

Verbindergroße Fastener Size Taille des agrafes	Inhalt Content Contenu	Für Transportbänder bis zu... N/mm Festigkeit For Belts with a Tensile Strength of up to... N/mm Pour bandes transporteuses à résistance de rupture jusqu'à... N/mm	empf. Bandstärkenbereich Belt Thickness Range Épaisseur de bandes recommandée mm	empf. kleinster Trommel-Ø rec. min. Pulley-Ø Ø tambour mini.rec. mm
BR-10	1,5 m	1250	6 - 17	450
BR-14	1,5 m	1600	10 - 24	900

Montagegeräte · Installation Tools Outillage de montage

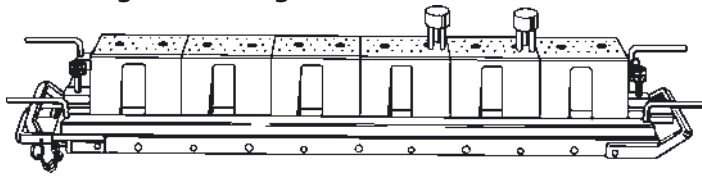

Bestell-Nr. Order-No. No. de réf.	Breite Width Largeur mm	Gewicht Weight Poids kg
MBRTA-42*	1050	66,5
MBRTA-48*	1200	76,0
MBRTA-60*	1500	95,0
MBRTA-72	1800	87,0
MBRTA-84	2100	102,0
MBRTA-96	2400	116,0
MBRTX-42	1050	42,0
MBRTX-48	1200	48,0

* mit Metallkoffer · with Tool Box · avec coffret métallique

Verbinder · Fasteners · Agrafes

Material Material Matériel	Bestell-Nr. Order-No. No. de réf.	Inhalt Content Contenu m	Gewicht Weight Poids kg
Stahl · Steel Acier	BR-10	1,5	3,63
	BR-14	1,5	5,86
MegAlloy	BR-10MA	1,5	3,63
	BR-14MA	1,5	5,86
Rostfrei · Stainless Inoxydable	BR-10S	1,5	3,63

Ersatzteile und Zubehör Spare Parts and Accessories Pièces de rechange et accessoires

Bestell-Nr. Order-No. No. de réf.	Gewicht Weight Poids kg
BR500D	1,36
BR151	0,23

Nieten Auswahltablelle Rivet Selection Chart Tableau de selection des rivets

Verbinder Fasteners Agrafes	Bandstärke Belt Thickness Épaisseur de bande	Größe Size Largeur
BR-10	6 - 8	SRA
	7 - 10	SRB
	9 - 11	SRC
	10 - 13	SRC/D
	12 - 14	SRD
	13 - 16	SRE
	15 - 17	SRF
BR-14	10 - 13	SRD
	12 - 14	SRE
	13 - 16	SRF
	15 - 17	SRG
	16 - 19	SRH
	18 - 21	SRI
	20 - 22	SRJ
	21 - 24	SRK

Nieten pro Verbindung Rivets per Splice Rivets par jonction

Bandbreite Belt Width Largeur de bande	BR-10	BR-14
400	90	126
500	110	154
650	140	196
800	170	238
1000	220	308
1200	270	378
1400	310	434
1600	360	504
1800	410	574

Nieten siehe Seite 15

Rivets on page 15

Rivets sur la page 15

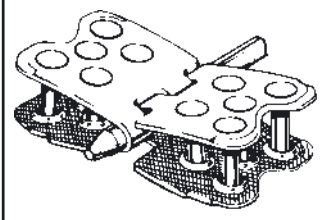

FLEXCO Rivet Hinged

Transportband -
Verbindungssystem
für Bandstärken von
5 bis 17 mm

Conveyor Belt Fastening
System for Belts
5 to 17 mm thick

Système d'agrafage pour
bandes transporteuses
d'épaisseur 5 - 17 mm

Verbindergroße Fastener Size Taille des agrafes	Für Transportbänder bis zu... N/mm Festigkeit For Belts with a Tensile Strength of up to... N/mm Pour bandes tranporteuses à résistance de rupture jusqu'à... N/mm	empf. Bandstärkenbereich Belt Thickness Range Épaisseur de bandes recommandée mm	empf. kleinster Trommel-Ø rec. min. Pulley-Ø Ø tambour mini.rec. mm
R2	400	6 - 10	125
R5	800	6 - 11	200

Inhalt: Jeder Karton enthält 2 Verbinderstreifen für die angegebene Bandbreite. Nieten und Kupplungsstäbe extra bestellen.

Content: Each Box contains two Fastener Strips for the Belt Width specified. Order Rivets and Hinge Pins separately.

Contenu: Chaque boîte contient deux bandes d'agrafes pour la largeur de bande spécifiée. Veuillez commander rivets et axes séparément.

Stahl verzinkt Galvanized Steel / Acier galvanisé

Bestell-Nr. Order-No. No. de réf.	Bandbreite Belt Width Largeur de Bande mm	Gewicht Weight Poids kg
R2-20/500	500	0,75
R2-26/650	650	0,97
R2-32/800	800	1,20
R2-40/1000	1000	1,50
R2-48/1200	1200	1,80
R2-55/1400	1400	2,00
R5-SE-20/500	500	1,27
R5-SE-26/650	650	1,66
R5-SE-32/800	800	2,20
R5-SE-40/1000	1000	2,54
R5-SE-48/1200	1200	3,13
R5-SE-55/1400	1400	3,56
R5-SE-63/1600	1600	4,10

MegAlloy

Bestell-Nr. Order-No. No. de réf.	Inhalt Content Contenu	Gewicht Weight Poids kg
R2MA	10 × 170 mm	1,4
R5MA-SE	10 × 170 mm	2,2
R5-1/2 MA-SE	10 × 170 mm	2,8

Stahl verzinkt / Galvanized Steel / Acier galvanisé

Inhalt: Jeder J-Karton enthält eine komplette Verbindung mit Nieten und NC-Kupplungsstab

Content: Each J-Box contains one complete splice with rivets and NC-hinge pin

Contenu: Chaque boîte J contient une jonction complète avec rivets et axe NC

Bestell-Nr. Order-No. No. de réf.	Bandbreite Belt Width Largeur de Bande mm	Gewicht Weight Poids kg
R2J-20/500ANC	500	0,75
R2J-26/650ANC	650	0,97
R2J-32/800ANC	800	1,20
R2J-40/1000ANC	1000	1,50
R2J-48/1200ANC	1200	1,80

Bandstärkenbereich/Belt Thickness Range/Épaisseur
de bande recommandée R2J: 6 - 8 mm

Rostfrei W.1.4401 / AISI 316 / Z6CND17-11 Stainless / Inoxydable

Bestell-Nr. Order-No. No. de réf.	Bandbreite Belt Width Largeur de Bande mm	Gewicht Weight Poids kg
R2S-20/500	500	0,75
R2S-26/650	650	0,97
R2S-32/800	800	1,20
R2S-40/1000	1000	1,50
R2S-48/1200	1200	1,80
R5S-SE-20/500	500	1,27
R5S-SE-26/650	650	1,66
R5S-SE-32/800	800	2,20
R5S-SE-40/1000	1000	2,54
R5S-SE-48/1200	1200	3,13
R5S-SE-55/1400	1400	3,56
R5S-SE-63/1600	1600	4,10

RustAlloy - W.1.4016 / AISI 430 / Z8C17 magnetisch / magnetic / magnétique

Bestell-Nr. Order-No. No. de réf.	Inhalt Content Contenu	Gewicht Weight Poids kg
RAR5-SE-26/650	650	1,66
RAR5-SE-32/800	800	2,20
RAR5-SE-40/1000	1000	2,54
RAR5-SE-48/1200	1200	3,13
RAR5-SE-55/1400	1400	3,56
RAR5-SE-63/1600	1600	4,10

Bestell-Nr. Order-No. No. de réf.	Bandbreite Belt Width Largeur de Bande mm	Gewicht Weight Poids kg
R5J-SE-20/500NC	500	1,27
R5J-SE-26/650NC	650	1,66
R5J-SE-32/800NC	800	2,20
R5J-SE-40/1000NC	1000	2,54
R5J-SE-48/1200NC	1200	3,13

Bandstärkenbereich/Belt Thickness Range/Épaisseur
de bande recommandée R5J: 7 - 11 mm

Verbindergroße Fastener Size Taille des agrafes	Für Transportbänder bis zu... N/mm Festigkeit For Belts with a Tensile Strength of up to... N/mm Pour bandes tranporteuses à résistance de rupture jusqu'à... N/mm	empf. Bandstärkenbereich Belt Thickness Range Épaisseur de bandes recommandée mm	empf. kleinster Trommel-Ø rec. min. Pulley-Ø Ø tambour mini.rec. mm
R5^{1/2}	1250	9 - 15	250
R6 / RAR6	1400 / 1600	10 - 17	400
R8 / RAR8	2000 / 2500	10 - 17	400
R9S	3500	16 - 24	1050

Inhalt: Jeder Karton enthält 2 Verbinderstreifen für die angegebene Bandbreite. Nieten und Kupplungsstäbe extra bestellen.

Content: Each Box contains two Fastener Strips for the Belt Width specified. Order Rivets and Hinge Pins separately.

Contenu: Chaque boîte contient deux bandes d'agrafes pour la largeur de bande spécifiée. Veuillez commander rivets et axes séparément.

Stahl verzinkt Galvanized Steel / Acier galvanisé

Bestell-Nr. Order-No. No. de réf.	Bandbreite Belt Width Largeur de Bande mm	Gewicht Weight Poids kg
R5-¹/₂-SE-26/650	650	2,40
R5-¹/₂-SE-32/800	800	2,95
R5-¹/₂-SE-40/1000	1000	3,68
R5-¹/₂-SE-48/1200	1200	4,49
R5-¹/₂-SE-55/1400	1400	5,16
R5-¹/₂-SE-63/1600	1600	5,89
R5-¹/₂-SE-72/1800	1800	6,63
R6-SE-32/800	800	4,00
R6-SE-40/1000	1000	5,00
R6-SE-48/1200	1200	6,00
R6-SE-55/1400	1400	7,00
R6-SE-63/1600	1600	8,00
R6-SE-72/1800	1800	9,00
R8-SE-40/1000	1000	5,00
R8-SE-48/1200	1200	6,00
R8-SE-55/1400	1400	7,00
R8-SE-63/1600	1600	8,00
R8-SE-72/1800	1800	9,00

RustAlloy - W.1.4016 / AISI 430 / Z8C17 magnetisch / magnetic / magnétique

Bestell-Nr. Order-No. No. de réf.	Bandbreite Belt Width Largeur de Bande mm	Gewicht Weight Poids kg
RAR5-¹/₂-SE-26/650	650	2,40
RAR5-¹/₂-SE-32/800	800	2,95
RAR5-¹/₂-SE-40/1000	1000	3,68
RAR5-¹/₂-SE-48/1200	1200	4,49
RAR5-¹/₂-SE-55/1400	1400	5,16
RAR5-¹/₂-SE-63/1600	1600	5,89
RAR5-¹/₂-SE-72/1800	1800	6,63
RAR6-SE-32/800	800	4,00
RAR6-SE-40/1000	1000	5,00
RAR6-SE-48/1200	1200	6,00
RAR6-SE-55/1400	1400	7,00
RAR6-SE-63/1600	1600	8,00
RAR6-SE-72/1800	1800	9,00
RAR8-SE-40/1000	1000	5,00
RAR8-SE-48/1200	1200	6,00
RAR8-SE-55/1400	1400	7,00
RAR8-SE-63/1600	1600	8,00
RAR8-SE-72/1800	1800	9,00

Rostfrei W.1.4401 / AISI 316 / Z6CND17-11 Stainless / Inoxydable

Bestell-Nr. Order-No. No. de réf.	Bandbreite Belt Width Largeur de Bande mm	Gewicht Weight Poids kg
R9S-SE-40/1000	1000	6,50
R9S-SE-48/1200	1200	7,70
R9S-SE-55/1400	1400	9,00
R9S-SE-63/1600	1600	10,00
R9S-SE-72/1800	1800	11,50

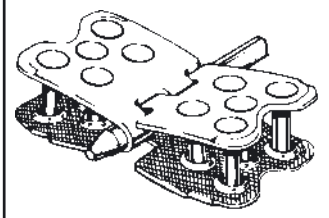

FLEXCO Rivet Hinged

Kupplungsstäbe

Hinge Pins

Axes de jonction

Stahl / Steel / Acier

Bestell-Nr. Order-No. No. de réf.	Ø mm	Verbinder Fasteners Agrafes	Bandbreite Belt Width Largeur de bande mm
NC-500-1	6,3	R2, R5, 375, 550	500
NC-650-1			650
NC-800-1			800
NC-1000-1			1000
NC-1200-1			1200
NC-1400-1			1400
NC-1600-1			1600
NC-C	Rolle / Coil / Rouleau 30 m		
SC-500-1	6,0	R2, R5, 375, 550	500
SC-650-1			650
SC-800-1			800
SC-1000-1			1000
SC-1200-1			1200
SC-C	Rolle / Coil / Rouleau 30 m		
AC-500-1	6,3	R2, R5, 375, 550	500
AC-650-1			650
AC-800-1			800
AC-1000-1			1000
AC-1200-1			1200
AC-1400-1			1400
AC-1600-1			1600
AC-3000-1			3000
NAC-500-1	6,3	R2, R5, 375, 550	500
NAC-650-1			650
NAC-800-1			800
NAC-1000-1			1000
NAC-1200-1			1200
NAC-1400-1			1400
NAC-1600-1			1600
AC6-650-1	9,6	R5-1/2, R6, R8	650
AC6-800-1			800
AC6-1000-1			1000
AC6-1200-1			1200
AC6-1400-1			1400
AC6-1600-1			1600
AC6-1800-1			1800
NAC6-800-1	10,3	R5-1/2, R6, R8	800
NAC6-1000-1			1000
NAC6-1200-1			1200
NAC6-1400-1			1400
NAC6-1600-1			1600
NAC6-1800-1			1800
SC6-650-1	8,8	R5-1/2, R6, R8	650
SC6-800-1			800
SC6-1000-1			1000
SC6-1200-1			1200
SC6-1400-1			1400
SC6-1600-1			1600

Rostfrei / Stainless / Inoxydable

Bestell-Nr. Order-No. No. de réf.	Ø mm	Verbinder Fasteners Agrafes	Bandbreite Belt Width Largeur de bande mm
NCS-500-1	6,3	R2, R5, 375, 550	500
NCS-650-1			650
NCS-800-1			800
NCS-1000-1			1000
NCS-1200-1			1200
NCS-1400-1			1400
NCS-1600-1			1600
NCS-C	Rolle / Coil / Rouleau 30 m		
SSC-500-1	6,0	R2, R5, 375, 550	500
SSC-650-1			650
SSC-800-1			800
SSC-1000-1			1000
SSC-1200-1			1200
ACS-500-1	6,3	R2, R5, 375, 550	500
ACS-650-1			650
ACS-800-1			800
ACS-1000-1			1000
ACS-1200-1			1200
ACS-1400-1			1400
ACS-1600-1			1600
ACS-3000-1			3000
ACS6-650-1	9,6	R5-1/2, R6, R8	650
ACS6-800-1			800
ACS6-1000-1			1000
ACS6-1200-1			1200
ACS6-1400-1			1400
ACS6-1600-1			1600
ACS6-1800-1			1800
NCS962-1200-1		R9	1200
NCS962-1400-1			1400
NCS962-1600-1			1600
NCS962-1800-1			1800
NCS975-1200-1		R9	1200
NCS975-1400-1			1400
NCS975-1600-1			1600
NCS975-1800-1			1800
Antimagnetisch / Non magnetic Anti-magnétique			
NB-500-1	6,3	R2, R5, 375, 550	500
NB-650-1			650
NB-800-1			800
NB-1000-1			1000
NB-1200-1			1200
NB-C	Rolle / Coil / Rouleau 30 m		

Nieten Auswahltable
Rivet Selection Chart
Tableau de selection des rivets

Verbinder Fasteners Agrafes	Bandstärke Belt Thickness Epaisseur de bande	Größe Size Largeur
R2	5 - 6	SRAA
	6 - 8	SRA
	7 - 10	SRB
R5	6 - 8	SRA
	7 - 10	SRB
	9 - 11	SRC
R5-1/2	8 - 9	SRB
	9 - 10,5	SRC
	10 - 12	SRC/D
	11 - 13,5	SRD
	13 - 15	SRE
R6 / R8	9 - 11	SRC/D
	10,5 - 13	SRD
	12 - 14	SRE
	13,5 - 16	SRF
	15 - 17	SRG
R9S	16,5 - 19	SRH
	18 - 21	SRI
	20 - 22	SRJ
	21 - 24	SRK

FLEXCO Rapid Loader-Nieten · Rivets · Rivets

Inhalt 60 Streifen / 1200 Niete pro Eimer
 Content 60 strips / 1200 rivets per bucket
 Contenu 60 bandes / 1200 rivets par seau

Bestell-Nr. Order-No. No. de réf.	Größe Size Taille	Farbe Colour Couleur	Gewicht Weight Poids kg
---	-------------------------	----------------------------	----------------------------------

Stahl / Steel / Acier

CSRLA	A	Rot/Red/Rouge	5,89
CSRLB	B	Weiß/White/Blanc	6,31
CSRLC	C	Blau/Blue/Bleu	6,72
CSRLC/D	C/D	Orange	7,05
CSRLD	D	Grün/Green/Vert	7,28
CSRLE	E	Lila/Purple/Lilas	7,53
CSRLF	F	Gelb/Yellow/Jaune	7,86
CSRLG	G	Schwarz/Black/Noir	8,11

Rostfrei / Stainless / Inoxydable

CSRLA-S	A	Rot/Red/Rouge	5,84
CSRLB-S	B	Weiß/White/Blanc	6,25
CSRLC-S	C	Blau/Blue/Bleu	6,76
CSRLC/D-S	C/D	Orange	6,94
CSRLD-S	D	Grün/Green/Vert	7,21
CSRLE-S	E	Lila/Purple/Lilas	7,47
CSRLF-S	F	Gelb/Yellow/Jaune	7,67
CSRLG-S	G	Schwarz/Black/Noir	7,94

Nieten pro Verbindung
Rivets per Splice
Rivets par jonction

Bandbreite Belt Width Largeur de bande	Platten Plates Plaques	R2	R5, 5-1/2, R6	R8/R9S
400	9	36	90	
500	11	44	110	
650	14	56	140	
800	18	72	180	
1000	22	88	220	352
1200	27	108	270	432
1400	31	124	310	496
1600	36	144	360	576
1800	41	164	410	656

FLEXCO-Nieten · Rivets · Rivets

Bestell-Nr. Order-No. No. de réf.	Größe Size Largeur	Inhalt Content Contenu	Gewicht Weight Poids kg
---	--------------------------	------------------------------	----------------------------------

Stahl / Steel / Acier

SRAA	SRAA	250	1,00
SRA	SRA	250	1,04
SRB	SRB	250	1,13
SRC	SRC	250	1,18
SRC/D	SRC/D	250	1,27
SRD	SRD	250	1,32
SRE	SRE	250	1,41
SRF	SRF	250	1,41
SRG	SRG	250	1,45
SRH	SRH	250	1,54
SRI	SRI	250	1,65
SRJ	SRJ	250	1,73
SRK	SRK	250	1,85

SRA-2M	SRA	2000	7,52
SRB-2M	SRB	2000	8,20
SRC-2M	SRC	2000	9,15
SRC/D-2M	SRC/D	2000	9,60
SRD-2M	SRD	2000	9,92
SRE-2M	SRE	2000	10,46
SRF-2M	SRF	2000	11,05
SRG-2M	SRG	2000	11,28

Rostfrei W.1.4016 / magnetisch
Stainless AISI 430 / magnetic
Inoxydable Z8C17 / magnétique

SRAA-S	SRAA	250	1,00
SRA-S	SRA	250	1,04
SRB-S	SRB	250	1,13
SRC-S	SRC	250	1,18
SRC/D-S	SRC/D	250	1,27
SRD-S	SRD	250	1,32
SRE-S	SRE	250	1,41
SRF-S	SRF	250	1,41
SRG-S	SRG	250	1,45

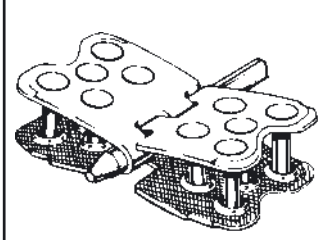

FLEXCO Rivet Hinged

Montagegeräte

Installation Tools

Outillage de montage

Bestell-Nr. Order-No. No. de réf.	Breite Width Largeur mm	Gewicht Weight Poids kg
R2T	300	3,00
MSRTX-30	750	23,00
MSRTX-36	900	25,00
MSRTX-42	1050	27,00
MSRTX-48	1200	29,00
MSRTX-60	1500	31,00
MSRTX-12-AL	300	10,00
MSRTX-30-AL	750	23,00
MSRTX-36-AL	900	25,00
MSRTX-42-AL	1050	27,00
MSRTX-48-AL	1200	29,00
MSRTX-60-AL	1500	31,00
MSRT-30E-AL*	750	39,00
MSRT-36E-AL*	900	44,00
MSRT-42E-AL*	1050	49,00
MSRT-48E-AL*	1200	54,00
MSRT-60E-AL*	1500	71,00
MSRT-72-AL	1800	46,00
MSRT8-48	1200	38,50
MSRT8-60	1500	42,00
MSRT8-72	1800	46,00
MSRT8-84	2100	50,00
MSRT8-48E*	1200	54,00
MSRT8-60E*	1500	69,00
MSRT9-48	1200	40,00
MSRT9-60	1500	42,00
MSRT9-72	1800	45,00
MSRT9-84	2100	50,00

Montagegeräte / Installation Tools / Outillage de montage

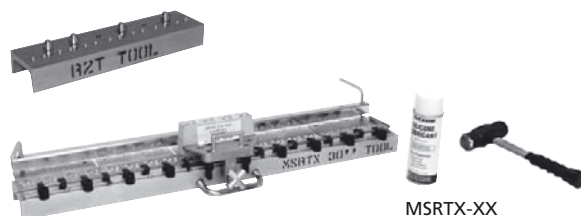

MSRTX-XX

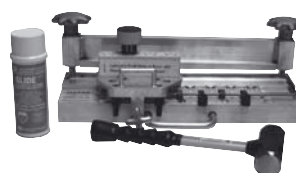

MSRTX-XX-AL



MSRTX-XXE-AL

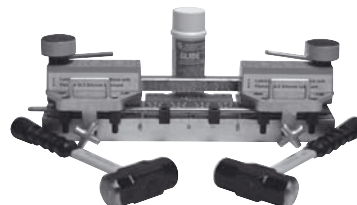

MSRT8-XX / MSRT9-XX

* mit Metallkoffer / with Tool Box / avec coffret métallique



Nietentreiber für Bosch-Schlaghammer
EPRD-DR

Drive Rod for Bosch
Demolition Hammer
EPRD-DR

Chasoir rivets pour
Marteau piqueur Bosch
EPRD-DR



Schlaghammer
BOSCH GSH5E

Demolition Hammer
BOSCH GSH5E

Marteau pneumatique
BOSCH GSH5E

Ersatzteile
und Zubehör

Spare Parts and
Accessories

Pièces de rechange
et accessoires

Bestell-Nr. Order-No. No. de réf.		Gewicht Weight Poids kg
SR700	Führungsblock/Guide Block/Bloc de guidage R5, R 5½, R6	1,36
SR800	Führungsblock/Guide Block/Bloc de guidage R8, R9S	1,36
SR759	Nietentreiber/Drive Rod/Chasoir de rivets R5, R 5½, R6	0,44
SR759-2	Nietentreiber/Drive Rod/Chasoir de rivets R2	0,40
SR859-8	Nietentreiber/Drive Rod/Chasoir de rivets R8, R9S	0,50
4FH	Hammer/Hammer/Marteau	2,00
SL5-1	Silikonspray/Silicone Spray/Silicone	0,62
SR50	Einzelnietentreiber komplett Individual Drive Rod complete Chasoir pour rivets individuels complet	0,35
SR5-7	Treiberstift/Drive Pin/Tige de chasoir	0,03
SR-CB	Kanvastasche/Canvas Bag/Poche de canevas	0,60
Extra Metallkoffer / Extra Tool Box Coffret métallique supplémentaire		
TB900		17,50
TB1200		18,50
TB1500		22,50



SR759 (R5 / R5½ / R6)
SR759-2 (R2)

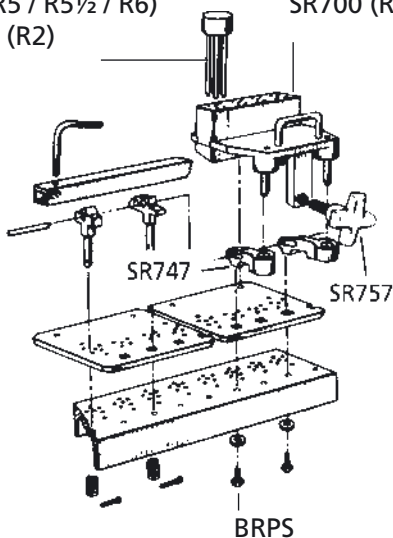

SR700 (R5 / R5½ / R6)

Bestell-Nr. Order-No. No. de réf.		Gewicht Weight Poids kg
SR24	Halterung/Gauge Pin Guide/Fixation	0,04
SR25	Halterung/Gauge Pin Guide/Fixation	0,04
SR22A	Amboßplatte komplett/Anvil Plate complete / Plaque d'enclume complète	0,80
SR23	Fixierschraube komplett/Tightening Bolt complete / Vis de fixation complète	0,10
SR757	Fixierschraube/Clamping Screw/ Vis de fixation	0,25
SR747	Nietenführungseinheit Rivet Guide Locator Assembly Unité de guidage de rivets	0,10
BRPS	Schrauben / Screws / Vis (50)	0,31
SR5-1	Schraubhülsen 2er-Set / Collets Set of 2 Douilles jeu de 2	0,04
SR2-30	Steckstift für / Gauge Pin for / Goupille pour MSRT-30 / MSRTX-30	
SR2-36	MSRT-36 / MSRTX-36	
SR2-42	MSRT-42 / MSRTX-42	
SR2-48	MSRT-48 / MSRTX-48	
SR2-60	MSRT-60 / MSRTX-60	
SR2-72	MSRT-72 / MSRTX-72	
SR2-84	MSRT-84 / MSRTX-84	
SR9-30	Klemmschiene für/Clamp Bar for/ Dispositif de serrage pour MSRT-30 / MSRTX-30	
SR9-36	MSRT-36 / MSRTX-36	
SR9-42	MSRT-42 / MSRTX-42	
SR9-48	MSRT-48 / MSRTX-48	
SR9-60	MSRT-60 / MSRTX-60	
SR9-72	MSRT-72 / MSRTX-72	
SR9-84	MSRT-84 / MSRTX-84	
R5-RAR6LP	Lehre zur Nietenauswahl / Rivet Gauge / Gabarit pour sélection des rivets	
R6-R8	Lehre zur Nietenauswahl / Rivet Gauge Gabarit pour sélection des rivets	

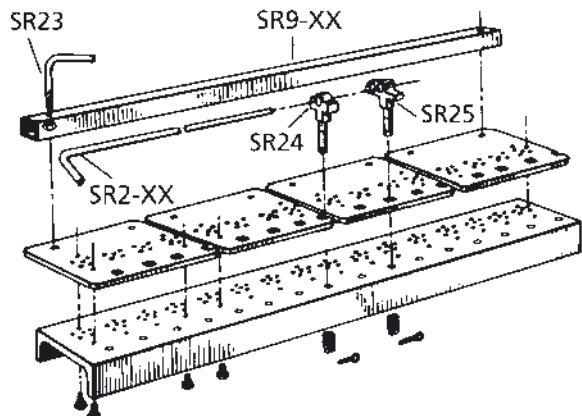
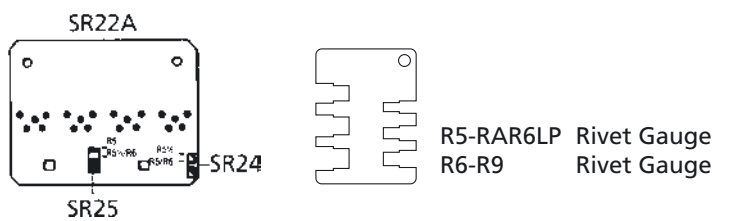

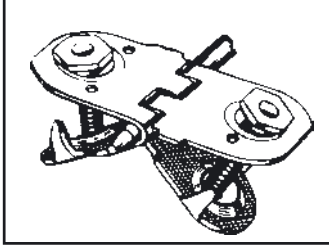

FLEXCO Bolt Hinged

Transportband -
Verbindungssystem für
Bandstärken
von 6 bis 16 mm

Conveyor Belt Fastening
System for Belts
6 to 16 mm thick

Système d'agrafage pour
bandes transporteuses
d'épaisseur 6 - 16 mm

Verbindergröße Fastener Size Taille des agrafes	Für Transportbänder bis zu... N/mm Festigkeit For Belts with a Tensile Strength of up to... N/mm Pour bandes tranporteuses à résistance de rupture jusqu'à... N/mm	empf. Bandstärkenbereich Belt Thickness Range Épaisseur de bandes recommandée mm	empf. kleinster Trommel-Ø rec. min. Pulley-Ø Ø tambour mini.rec. mm
375X	400	6 - 10	125
550	500	6 - 16	200

Inhalt: Jeder J-Karton enthält 1 komplette Verbindung für die angegebene Bandbreite.

Content: Each J-Box contains 1 Set Lacing for the Belt Width specified.

Contenu: Chaque boîte J contient 1 jeu complet de jonction pour la largeur de bande spécifiée.

Stahl verzinkt Galvanized Steel / Acier galvanisé

Bestell-Nr. Order-No. No. de réf.	Bandbreite Belt Width Larg. de bande mm	Gewicht Weight Poids kg
375XJ400NC-SN	400	1,28
375XJ500NC-SN	500	1,59
375XJ650NC-SN	650	2,07
375XJ800NC-SN	800	2,55
375XJ1000NC-SN	1000	3,18
375XJ1200NC-SN	1200	3,77
375XJ1400NC-SN	1400	4,46
550J500NC-SN	500	1,66
550J650NC-SN	650	2,16
550J800NC-SN	800	2,66
550J1000NC-SN	1000	3,32
550J1200NC-SN	1200	4,00
550J1400NC-SN	1400	4,65

MegAlloy

550MAJ650SC-SN	650	2,1
550MAJ800SC-SN	800	2,7
550MAJ1000SC-SN	1000	3,3
550MAJ1200SC-SN	1200	4,0

Lose-Verbinder (mit Schrauben und Muttern) Bulk Fasteners (with Bolts and Nuts) Plaques d'agrafes individuelles (avec vis et écrous)

Stahl / Steel / Acier

Bestell-Nr. Order-No. No. de réf.	Platten Plates Plaques	Sets/Eimer Sets/Box Jeux/seau	Gewicht Weight Poids kg
375X-3-SN	3	18	3,86
550-1-SN	1	50	5,44
550-3-SN	3	18	5,90

Extra Kupplungsstäbe auf Seite 14
Extra Hinge Pins on Page 14
Axes de jonction supplémentaires page 14

Rostfrei Stainless / Inoxydable

Bestell-Nr. Order-No. No. de réf.	Bandbreite Belt Width Larg. de bande mm	Gewicht Weight Poids kg
375XSJ400NCS	400	1,28
375XSJ500NCS	500	1,59
375XSJ650NCS	650	2,07
375XSJ800NCS	800	2,55
375XSJ1000NCS	1000	3,18
375XSJ1200NCS	1200	3,77
375XSJ1400NCS	1400	4,46
550SJ500SSC	500	1,66
550SJ650SSC	650	2,16
550SJ800SSC	800	2,66
550SJ1000SSC	1000	3,32
550SJ1200SSC	1200	4,00
550SJ1400SSC	1400	4,65

Antimagnetisch / Non magnetic / Anti-magnétique







375XEJ500NB	500	1,59
375XEJ650NB	650	2,07
375XEJ800NB	800	2,55
375XEJ1000NB	1000	3,18
375XEJ1200NB	1200	3,77
550SJ650NB	650	2,16
550SJ800NB	800	2,66
550SJ1000NB	1000	3,32
550SJ1200NB	1200	4,00
550SJ1400NB	1400	4,50

Rostfrei / Stainless / Inoxydable

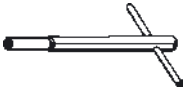
Bestell-Nr. Order-No. No. de réf.	Platten Plates Plaques	Sets/Krt. Sets/Box Jeux/bte.	Gewicht Weight Poids kg
375XS-2	2	25	2,86
375XS-3	3	18	3,68
550S-1	1	50	5,49

Extra Schrauben und Muttern auf Seite 23
Extra Bolts and Nuts on Page 23
Vis et écrous supplémentaires page 23

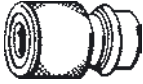
Montagewerkzeuge · Installation Tools · Outils de montage

		Bestell-Nr. Order-No. No. de réf.	Verbindergroße Fastener Size Taille d'agrafe	Gewicht Weight Poids kg
Manuelle Montage · Hand Tools · Montage manuel				
	Schraubendreher Bolt Breaker Casse-vis	110	375 + 550	0,60
	Lochisen Punch Poinçon	P1P	375 + 550	0,06
	Schraubenschlüssel Wrench Clé à tube	S1S	375 + 550	0,09
Für Schlagschrauber · Power Tools · Outils pour boulonneuse à percussion				
	Lochisen Punch Poinçon	HP1	375 + 550	0,07
	Schraubenschlüssel Wrench Clé à tube	HW1	375 + 550	0,11
	Schnellkupplung Quick Change Chuck Mandrin serrage rapide	5552	375 + 550	0,16
	Füllschlauch orange (30 m) Orange Filler Tubing (30 m) Tuyau orange (30 m)	30894	375 + 550	0,36

Bohrschablonen · Templets · Gabarits

Bestell-Nr. Order-No. No. de réf.	Bandbreite Belt Width Largeur de bande mm	Gewicht Weight Poids kg	Bestell-Nr. Order-No. No. de réf.	Bandbreite Belt Width Largeur de bande mm	Gewicht Weight Poids kg
für/for/pour 375			für/for/pour 550		
375X-500	500	1,05	5-500	500	1,05
375X-650	650	1,36	5-650	650	1,36
375X-800	800	1,68	5-800	800	1,68
375X-1000	1000	2,09	5-1000	1000	2,09
375X-1200	1200	2,51	5-1200	1200	2,51
375X-1400	1400	2,93	5-1400	1400	2,93

Bandschneider, Serie 400 Belt Cutter 400 Series Coupeuse de bande Série 400

400430	750	6,42
400436	900	7,32
400442	1050	8,59
400448	1200	8,62
400460	1500	10,43

FLEXCO-LOK Band FLEXCO-LOK Tape Bande FLEXCO-LOK

Bestell-Nr. Order-No. No. de réf.	für for pour	Länge Length Longueur m	Gewicht Weight Poids kg
FL7C	375X/550	30	0,36

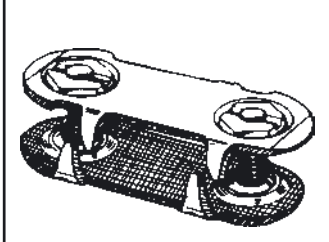

FLEXCO Bolt Solid Plate

Transportband -
Verbindungssystem für
Bandstärken
von 5 bis 30 mm

Conveyor Belt Fastening
System for Belts
5 to 30 mm thick

Système d'agrafage pour
bandes transporteuses
d'épaisseur 5 - 30 mm

Verbindergroße Fastener Size Taille des agrafes	Für Transportbänder bis zu... N/mm Festigkeit For Belts with a Tensile Strength of up to... N/mm Pour bandes tranporteuses à résistance de rupture jusqu'à... N/mm	empf. Bandstärkenbereich Belt Thickness Range Épaisseur de bandes recommandée mm	empf. kleinster Trommel-Ø rec. min. Pulley-Ø Ø tambour mini.rec. mm
1	315	5 - 11	250
140	400	5 - 11	300
190	630	8 - 14	400
1-1/2	500	11 - 17	400
2	800	14 - 21	700
2-1/4	1000	14 - 30	850
2-1/2	800	19 - 25	1000
3	1000	24 +	1200

Bestell-Nr. Order-No. No. de réf.	Inhalt Content Contenu	Gewicht Weight Poids kg	Bestell-Nr. Order-No. No. de réf.	Inhalt Content Contenu	Gewicht Weight Poids kg
---	------------------------------	----------------------------------	---	------------------------------	----------------------------------

E-Stahl / Steel / Acier

1E	25	1,32
140E	25	2,08
190E	25	2,17
1-1/2E	25	2,68
2E	25	3,63
2-1/4E	25	4,89
2-1/2E	10	2,90
3	10	3,18

C-Stahl / Steel / Acier

1C	100	4,94
140C	100	7,12
190C	100	8,39
1-1/2C	100	9,93
2C	100	13,74
2-1/4C	100	19,18
2-1/2C	100	29,03
3C	100	31,29

E-MegAlloy Oberplatten/Top Plates/plaquettes supérieures

140EMA	25	2,08
190EMA	25	2,17
1-1/2EMA	25	2,68
2EMA	25	3,63

C-MegAlloy

140CMA	100	7,12
190CMA	100	8,39
1-1/2CMA	100	9,93
2CMA	100	13,74

E-Rostfrei / Stainless / Inoxydable

140ES	25	2,08
190ES	25	2,17
1-1/2ES	25	2,68
2ES	25	3,63

Reparatur-Set Eimer mit 50 Verbindern, HP1, HW1, 110
und ca. 5 m LOK-Band

Repair Set Bucket containing 50 fasteners, HP1, HW1, 110
and approx. 5 m LOK Tape

E-Everdur

140EE	25	2,08
190EE	25	2,17
1-1/2EE	25	2,68
2EE	25	3,63

Jeu de réparation Seau avec 50 agrafes, HP1, HW1, 110
et env. 5 m de bande LOK

FVS 140 6,24
FVS 190 6,51

VP-Vulcanized Plate

Bestell-Nr. Order-No. No. de réf.	Bandbreite Belt Width Largeur de bande mm	Gewicht Weight Poids kg
140VP	900 (5 X 180 mm)	2,48
190VP	900 (5 X 180 mm)	2,62
2VP	900 (5 X 180 mm)	3,58

Platten pro Verbindung Fasteners per Splice Plaquettes par jonction

Bandbreite Belt Width Largeur de bande mm	Grösse Size Taille		Grösse Size Taille		Grösse Size Taille	
	1, 140, 190 90°	45°	1-1/2, 2, 2-1/4 90°	45°	2-1/2, 3 90°	45°
400	13	19	10	15	8	12
500	16	26	13	21	10	16
650	21	33	17	27	14	21
800	26	40	21	32	17	26
1000	32	45	26	36	21	29
1200	39	54	31	43	26	35
1400	46	71	37	51	30	40

Rißreparaturverbinder · Rip Repair Fasteners · Agrafes pour réparation de déchirure

Bestell-Nr. Order-No. No. de réf.	Inhalt Content Contenu	Gewicht Weight Poids kg	Bestell-Nr. Order-No. No. de réf.	Inhalt Content Contenu	Gewicht Weight Poids kg
Stahl / Steel / Acier			Rostfrei / Stainless / Inoxydable		
RP1E	25	2,14	RP1ES	25	2,24
RP2E	25	4,64	RP2ES	25	4,57
16	50	1,96			

FLEXCO Wedlock Verbindung* · FLEXCO Wedlock Splice* · FLEXCO Agrafes Wedlock*

*Weitere Informationen vgl. Broschüre FW/200 · More information in bulletin FW/200 · Plus d'information dans le bulletin FW/200

Bestell-Nr. Order-No. No. de réf.		Gewicht Weight Poids kg
	2W Verbinderset – Splice Kit – Jeu d'agrafes	1,81
	2WS Verbinderset rostfrei – Stainless Splice Kit – Jeu d'agrafes inoxydable	1,81
	2WL Verbinderset Zugseite – Leading End Kit – Jeu d'agrafes extrémité tirante	1,36
	2WT Verbinderset gezogene Seite – Trailing End Kit – Jeu d'agrafes extrémité tirée	1,32
	T2W Bohrschablonenset – Wedlock Templet Set – Jeu de gabarits	2,86

SS Sechszackverbinder Stahl · Sixpoint Fasteners Steel · Agrafes à griffes acier

Bestell-Nr. Order-No. No. de réf.	Stück Pieces Pièces mm	Bandstärke Belt Thickness Epais. de bande mm	Spitzenlänge Point Length Longueur Pointes	
	SS200	100	2,5 - 4	8
	SS201	100	4 - 6	10
	SS202	100	6 - 8	12
	SS203	100	8 - 10	15
	SS204	100	10 - 13	20
	SS205	100	13 - 15	23
	SS206	100	15 - 18	27
	SS207	100	18 - 21	35

Bohrschablonen · Templets · Gabarits

Bestell-Nr. Order-No. No. de réf.	Bestell-Nr. Order-No. No. de réf.	Bestell-Nr. Order-No. No. de réf.	Bandbreite Belt Width Largeur de bande mm	Gewicht Weight Poids kg
1-500	140-500	190-500	500	1,0
1-650	140-650	190-650	650	1,3
1-800	140-800	190-800	800	1,6
1-1000	140-1000	190-1000	1000	2,0
1-1200	140-1200	190-1200	1200	2,4
1-1400	140-1400	190-1400	1400	2,8
1-1/2-800	2-800		800	1,6
1-1/2-1000	2-1000		1000	2,0
1-1/2-1200	2-1200		1200	2,4
1-1/2-1400	2-1400		1400	2,8
2-1/4-800	2-1/2-800	3-800	800	1,6
2-1/4-1000	2-1/2-1000	3-1000	1000	2,0
2-1/4-1200	2-1/2-1200	3-1200	1200	2,4
2-1/4-1400	2-1/2-1400	3-1400	1400	2,8

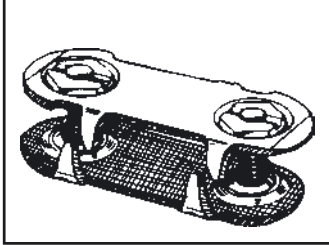

**Montagewerkzeuge
für FLEXCO
Bolt Solid Plate**

**Installation Tools
for FLEXCO
Bolt Solid Plate**

**Outillage de montage
pour FLEXCO
Bolt Solid Plate**

		Bestell-Nr. Order-No. No. de réf.	Verbindergroße Fastener Size Taille d'agrafe	Gewicht Weight Poids kg
Manuelle Montage · Hand Tools · Montage manuel				
	Schraubenbrecher	110	1, 140, 190, RP1, 375X, 550	0,60
	Bolt Breaker	112	1-1/2, 2, 2-1/4, RP2	0,66
	Casse-vis	113	2-1/2, 3	0,90
	Lochisen	P1P	1, 140, 190, RP1, 375X, 550	0,06
	Punch	P2P	1-1/2, 2, 2-1/4, RP2	0,10
	Poinçon	P3P	2-1/2, 3	0,13
	Steckschlüssel	S1S	1, 140, 190, RP1, 375X, 550	0,09
	Wrench	S2S	1-1/2, 2, 2-1/4, RP2	0,09
	Clé à tube	S3S	2-1/2, 3	0,11
	Schraubenhorn Bolthorn Corne à vis	2BH		0,02
	Meißel	C1C	1, 140, 190, RP1, 375X, 550	0,54
	Cracking Chisel Burin	C2C	1-1/2, 2, 2-1/4, RP2	0,54
Für Schlagschrauber · Power Tools · Outils pour boulonneuse à percussion				
	Lochisen	HP1	1, 140, 190, RP1, 375X, 550	0,07
	Punch	HP2	1-1/2, 2, 2-1/4, RP2	0,07
	Poinçon	HP3	2-1/2, 3	0,10
	Steckschlüssel	HW1	1, 140, 190, RP1, 375X, 550	0,11
	Wrench	HW2	1-1/2, 2, 2-1/4, RP2	0,14
	Clé à tube	HW3	2-1/2, 3	0,17
	Schnellkupplung Quick Change Chuck Mandrin serrage rapide	5552	für HP + HW Werkzeuge for HP + HW Tools pour Outillage HP + HW	0,16
FLEXCO-LOK Band · FLEXCO-LOK Tape · Bande FLEXCO-LOK				
	Bestell-Nr. Order-No. No. de réf.	für for pour	Länge Length Longueur m	Gewicht Weight Poids kg
	FL7C	1, 140	30	0,36
FL11C	190, 1-1/2, 2, 2-1/4, 2-1/2, 3	30	0,45	
	Makita Schlagschrauber Nr. 6905H	Makita Impact Tool Nr. 6905H	Boulonneuse Makita n° 6905H	

Extra Schrauben und Muttern

Extra Bolts and Nuts

Vis et écrous supplémentaires

Extra Schrauben Extra Bolts Vis supplémentaires

Stahl / Steel / Acier

Bestell-Nr. Order-No. No. de réf.	Verbindergröße Fastener Size Taille des agrafes	Gewicht Weight Poids kg
20391	1	0,80
20398	RP1, 375X	1,10
20399	140, 190, 550	1,00
20402	1-1/2	1,50
20406	2, RP2	1,80
20410	2-1/4	2,20
20414	2-1/2, 3	3,40

Rostfrei / Stainless / Inoxydable

20400	140, 190, 375X, 550, RP1	1,50
20407	1-1/2, 2, RP2	1,80
20411	2-1/4	2,20

Everdur

20397	140, 190	0,84
20409	1-1/2, 2, RP2	1,68

Locheisensatz / Belt Punch Set / Jeu de poinçons

Bestell-Nr. Order-No. No. de réf. (6 - 24 mm)	Gewicht Weight Poids kg
LS-1/06-24	1,36

Lochisen einzeln / Belt Punch Spares / Poinçon de rechange

Bestell-Nr. Order-No. (No. de réf.)	Ø mm	Gewicht Weight Poids kg
L-06	6	0,06
L-08	8	0,06
L-10	10	0,06
L-12	12	0,12
L-14	14	0,12
L-16	16	0,12
L-18	18	0,18
L-20	20	0,18
L-22	22	0,18
L-24	24	0,18

Extra Muttern Extra Nuts Écrous supplémentaires

Stahl / Steel / Acier

Bestell-Nr. Order-No. No. de réf.	Verbindergröße Fastener Size Taille des agrafes	Gewicht Weight Poids kg
20377	1, 140, 190, RP1 + 375X, 550	0,30
20378	1-1/2, 2, 2-1/4, RP2	0,50
20379	2-1/2, 3	1,00

Rostfrei / Stainless / Inoxydable

20381	1, 140, 190, RP1 + 375X, 550	0,30
20382	1-1/2, 2, 2-1/4, RP2	0,50

Everdur

20387	1, 140, 190, RP1 + 375X	0,30
20388	1-1/2, 2, 2-1/4, RP2	0,50



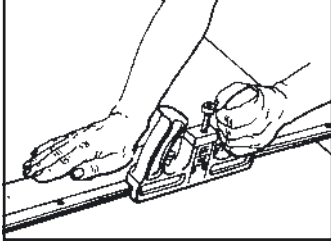





**ALLIGATOR/FLEXCO
Bandschneider und
Zubehör**

**ALLIGATOR/FLEXCO
Belt Cutters and
Accessories**

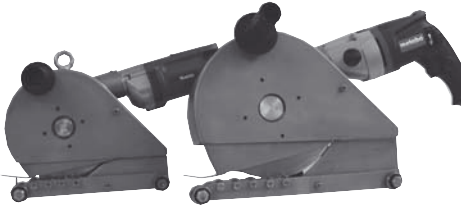
**ALLIGATOR/FLEXCO
Coupeuses de bande
et Accessoires**

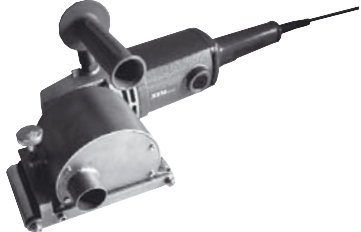
	Bestell-Nr. Order-No. No. de réf.	Breite Width Largeur mm	Gewicht Weight Poids kg		
	Bandschneider	300324	600	8,00	
	Belt Cutter	300330	750	8,70	
	Coupeuse de bande	300336	900	9,00	
		300342	1050	11,80	
		300348	1200	12,70	
		300360	1500	14,90	
		300372	1800	17,00	
		30023	Klinge/Blade/Lame		0,10
	300	Griff/Handle/Manche		1,10	
	8D	Nägel/Nails/Clous		0,50	
	845XXXLD	845836LD	900	12,00	
	Bandschneider	845848LD	1200	14,00	
	Belt Cutter	845860LD	1500	17,00	
	Coupeuse de bande	845872LD	1800	19,00	
	-12 mm	840WA	Griff/Handle/Manche		1,27
		840SD	Rechtw. Anschlagschiene Squaring device Rail fixe rectangulaire		0,10
		845-CBK	Klinge/Blade/Lame		0,10
	840XXX	840836	900	12,00	
	Bandschneider	840848	1200	14,00	
	Belt Cutter	840860	1500	17,00	
	Coupeuse de bande	840872	1800	19,00	
	10 - 20 mm	840884	2100	22,00	
		840WA	Griff/Handle/Manche		1,27
		840SD	Rechtw. Anschlagschiene Squaring device Rail fixe rectangulaire		0,10
	820/840-1CB	Klinge/Blade/Lame		0,10	
	Elektro Bandschneider	ITEC-170	Schneider/Cutter/Coupeuse		14,30
	Electric Belt Cutter	ITEC-170-BLADE	Klinge/Blade/Lame		1,00
	Coupeuse de bande électrique	ITEC-220	Schneider/Cutter/Coupeuse		18,40
	(230 V / 50 Hz)	ITEC-220-BLADE	Klinge/Blade/Lame		1,50
	Elektro Raumaschine	ITMBM		10,00	
	Electric Buffing Machine	VW110-390	Satz mit 4 Rauhscheiben Set of 4 vain wheels Jeu de 4 meuleuses		1,60
Machine électrique à meuler					



Bandhobel
Belt Skiver
Rabot pour bande

Bestell-Nr.
Order-No.
No. de réf.

EDV-Nr.
Item-No.
No. inf.

Gewicht
Weight
Poids
kg

FSK-1A
FSK-1BA

31995
31996

Hobel/Skiver/Rabot
verbesserte Klinge
improved Blade
Lame améliorée

9,30
0,10

FSK-1B

31996

Klinge/Blade/Lame

0,10

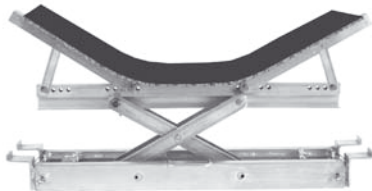

Gurtheber
FLEX-Lifter
Elévateur de bande

Bestell-Nr.
Order-No.
No. de réf.

für Bandbreite von
for Belt Width of
pour largeur de bande de
mm

Gewicht
Weight
Poids
kg

FLEX-LIFTER M
FLEX-LIFTER L

900 - 1500
1200 - 1800

39,00
57,20



Akkuschrauber
für Flex-Lifter
DeWalt DC920KB

Cordless Drill
for Flex-Lifter

DeWalt DC920KB

Visseuse sans fil
pour Flex-Lifter

DeWalt DC920KB

Bandspannsysteme
Far-Pull Belt Clamps
Pinceur de bande

Bestell-Nr.
Order-No.
No. de réf.

Bandbreite
Belt Width
Largeur de bande
mm

Gewicht
Weight
Poids
kg

mit 4 Klemmbalken
und 4 Klemmen
with 4 clamp
bars and 4 scissors
avec 4 barres et
4 pinces

LSHD30/750
LSHD36/900
LSHD42/1050
LSHD48/1200
LSHD60/1500
LSHD72/1800

750
900
1050
1200
1500
1800

29,50
32,50
35,00
39,00
44,00
48,00

Klemmbalkenset (2 Stück)
Belt Clamp Bar Set (2 Pieces)
Jeu de barres (2 pièces)

LSHDB30/750
LSHDB36/900
LSHDB42/1050
LSHDB48/1200
LSHDB60/1500
LSHDB72/1800

750
900
1050
1200
1500
1800

9,00
10,50
12,00
13,50
16,50
18,00

LSHDS Klemme / Scissors / Pinces

2,75

ALLIGATOR/FLEXCO
Zubehör

ALLIGATOR/FLEXCO
Accessories







ALLIGATOR/FLEXCO
Accessoires

		Bestell-Nr. Order-No. No. de réf.	Gewicht Weight Poids kg
	Kupplungsstabschneider Hinge Pin Cutter Pince à couper les axes de jonction	APC-1	0,23
	Bandeckentrimmzange Belt Nippers Pince à rogner	BN-1	0,36
	Rillenhobel Hand Skiver Rabot pour courroie	RTBS-F	0,06
	Bandschleifer Belt Grinder Meule pour bande	RB-1	0,34
	Bandhalter (Paar) Belt Grip (Pair) Poignée pour bande (Jeux)	22	1,13
	Bandkebler Belt Grover Rabot pour bande	FBG1 HSP3	0,82 0,02
	Silikon Spray Silicon Spray Silicone	SL5-1	0,62

ROCKLINE
Förderbandzentrier-
stationen und
Seitenabdichtungen

ROCKLINE
Conveyor Belt
Positioner and Skirt
Clamp



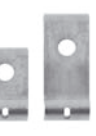

ROCKLINE
Station de centrage pour
bandes transporteuses et
système latéral d'étanchéité

		Bestell-Nr. Order-No. No. de réf.	Bandbreite Belt Width Largeur de bande mm	Gewicht Weight Poids kg
<p>Förderbandzentrierstationen Conveyor Belt Positioner Station de centrage pour bandes transporteuses</p> 	mit Exalon Rollen with Exalon Rollers avec rouleaux exalone	RBP1E-S RBP1E-M RBP1E-L RBP1E-XL	450 - 600 750 - 1200 1350 - 1800 1800 - 2400	27,40 33,30 42,60 82,50
	mit Stahl Rollen with Steel Rollers avec rouleaux en acier	RBP1S-S RBP1S-M RBP1S-L RBP1S-XL	450 - 600 750 - 1200 1350 - 1800 1800 - 2400	31,70 38,30 49,60 90,50
	Standardausführung Inhalt: 2 Antivibrationshaltestifte, 2 Klemmplatten, 1 Halteschiene 1,2 m lang	RMC1		5,30
	Standard length Content: 2 Antivibration clamp pins, 2 clamp plates, 1 clamp bar 1,2 m long			
	Version standard Contenu: 2 clavettes antivibration, 2 cales, 1 barre de calage de longueur 1,2 m			
	Sonderausführung mit kurzen Klemmplatten (LS) Inhalt: 2 Antivibrationshaltestifte, 2 Klemm- platten (kurz), 1 Halteschiene 1,2 m lang	RMC1-LS		4,70
Limited Space Edition (LS) Content: 2 Antivibration clamp pins, 2 limited space clamp plates, 1 clamp bar 1,2 m long				
Version spéciale avec cales courtes Contenu: 2 clavettes antivibration, 2 cales courtes, 1 barre de calage de longueur 1,2 m				
 <p>PAL PAK</p>  <p>12,6 cm LS</p>  <p>17,8 cm Standard</p>		PAL PAK LS PAL PAK		3,00 2,50
	 <p>Bolt-On PAL PAK</p>  <p>12,6 cm LS</p>  <p>17,8 cm Standard</p>		Bolt-On PAL PAK Bolt-On LS PAL PAK	
Bestell-Nr. Order-No. No. de réf.				Gewicht Weight Poids kg
RMC1-CP	Haltestift / Clamp Pin / Clavette			0,50
RMC1-BCP	Haltestift zum Schrauben / Bolt-on Clamp Pin / Goupille à visser			0,45
RMC1-PL	Klemmplatte / Clamp Plate / Cale			0,95
RMC1LS-PL	Klemmplatte kurz / Limited Space Clamp Plate / Cale courte			0,68
RMC1-CB	Halteschiene / Clamp Bar / Barre de calage			1,81

**ROCKLINE/
ELIMINATOR**
Bandreinigungssysteme

**ROCKLINE/
ELIMINATOR**
Diagonal Plow/
Precleaner

**ROCKLINE/
ELIMINATOR**
Chasse-pierres diagonal/
Pré-racleur

		Bestell-Nr. Order-No. No. de réf.	Bandbreite Belt Width Largeur de bande mm	Gewicht Weight Poids kg	
	ROCKLINE	RDP1-S	450 - 750	20,40	
	Diagonal Pflugabstreifer	RDP1-M	900 - 1050	25,40	
	Diagonal Plow	RDP1-L	1200 - 1500	31,70	
	Chasse-pierres diagonal	RDP1-XL	1800 - 2100	43,50	
	Ersatzblätter	RDPBK-S	450 - 750	1,80	
	Replacement Blade Kits	RDPBK-M	900 - 1050	2,50	
	Kit de remplacement de lame	RDPBK-L	1200 - 1500	3,80	
		RDPBK-XL	1800 - 2100	5,50	
<p>Hinweis: Verwenden Sie den grösseren Abstreifer bei Zwischenbandbreiten Notice: Use next larger size for belt widths between ranges Remarque: Pour des largeurs de bandes intermédiaires, utilisez le modèle supérieur</p>					
	ELIMINATOR	CBV-XS	450 - 600	24,00	
	V-Pflugabstreifer	CBV-S	750 - 900	29,45	
	V-Plow	CBV-M	1050 - 1200	33,50	
	Chasse-pierres en V	CBV-L	1350 - 1500	38,05	
	Ersatzblätter	VBK-XS		2,05	
	Replacement Blade Kits	VBK-S		2,70	
	Kit de remplacement de lame	VBK-M		3,40	
		VBK-L		4,10	
	Ersatzblätter aus Urethan	VUBK-XS		2,45	
	Urethane Blade Kits	VUBK-S		3,65	
Kit de remplacement de lame en uréthane	VUBK-M		4,75		
	VUBK-L		5,90		
<p>Hinweis: Verwenden Sie den grösseren Abstreifer bei Zwischenbandbreiten Notice: Use next larger size for belt widths between ranges Remarque: Pour des largeurs de bandes intermédiaires, utilisez le modèle supérieur</p>					
		Bestell-Nr. Order-No. No. de réf.	Bandbreite Belt Width Largeur de bande mm	Blattbreite Blade Width Largeur Lame mm	Gewicht Weight Poids kg
	ROCKLINE	EZP1-824	500	400	25,90
	Kopfabstreifer mit ConShear	EZP1-830	650	550	28,60
	Blätter	EZP1-836	800	700	31,25
	Precleaner with ConShear	EZP1-842	1000	850	34,00
	Blades	EZP1-848	1200	1000	36,60
	Pré-racleur avec lames	EZP1-854	1350	1150	39,30
	ConShear	EZP1-860	1400	1300	42,00
		EZP1-866	1600	1450	43,20
		EZP1-872	1800	1600	44,60
	MINELINE	MSP-824	500	400	36,50
	Kopfabstreifer mit ConShear	MSP-830	650	500	39,40
	Blätter	MSP-836	800	700	43,30
	Precleaner with ConShear	MSP-842	1000	850	46,80
	Blades	MSP-848	1200	1000	50,10
	Pré-racleur avec lames	MSP-854	1350	1150	53,10
	ConShear	MSP-860	1400	1300	55,80
		MSP-866	1600	1450	59,80
	MSP-872	1800	1600	61,00	

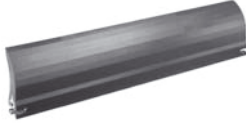
		Bestell-Nr. Order-No. No. de réf.	für Modell for Cleaner pour racleur	Blattbreite Blade Width Largeur lame mm	Gewicht Weight Poids kg
	ROCKLINE / MINELINE	CRB16	EZP1-824/MSP-824	405	3,30
	ConShear Ersatzblätter	CRB22	EZP1-830/MSP-830	550	4,60
	ConShear Spare Blades	CRB28	EZP1-836/MSP-836	710	5,80
	Lames de remplacement	CRB34	EZP1-842/MSP-842	860	7,00
	ConShear	CRB40	EZP1-848/MSP-848	1015	8,30
		CRB46	EZP1-854/MSP-854	1170	9,50
		CRB52	EZP1-860/MSP-860	1320	10,80
		CRB58	EZP1-866/MSP-866	1475	12,00
		CRB64	EZP1-872/MSP-872	1625	13,30

	MINELINE				
	Kits für sich im Einsatz befindende Kopfabstreifer		Cartridge Kits for Competition Cleaners	Kit d'installation pour autres racleurs en service	
Bestell-Nr. Order-No. No. de réf.	Bandbreite Belt Width Largeur de bande	SSRB Blätter SSRB Blades Lames SSRB mm	Gesamtbreite Total Width Largeur total mm	Gewicht Weight Poids kg	
MHCP-BCK24	500 - 600	3	450	15,00	
MHCP-BCK30	650 - 750	4	600	20,00	
MHCP-BCK36	800 - 900	5	750	25,00	
MHCP-BCK42	1000 - 1050	6	900	30,00	
MHCP-BCK48	1100 - 1200	7	1050	35,00	
MHCP-BCK54	1300 - 1350	8	1200	40,00	
MHCP-BCK60	1400 - 1500	9	1350	45,00	
MHCP-BCK72	1600 - 1800	10	1500	55,00	

SSRB	SuperShear Blatt / SuperShear Blade / Lame SuperShear	2,95
-------------	---	------

	ROCKLINE				
	EZS – Sekundärabstreifer EZS – Secondary Belt Cleaners EZS – Racleurs secondaires				
Bestellnummer Order-No. No. de réf.	Bandbreite Belt Width Largeur de bande	Blattbreite Blade Width Largeur de lame	Klingen Blades Lames	Gewicht Weight Poids kg	
EZS2-18	500	450	3	32,20	
EZS2-24	650	600	4	34,40	
EZS2-30	800	750	5	36,10	
EZS2-36	1000	900	6	38,70	
EZS2-42	1200	1050	7	40,50	
EZS2-48	1400	1200	8	42,70	
EZS2-54	1400	1350	9	44,90	
EZS2-60	1600	1500	10	61,80	
Ersatzklingen – Replacement Tips – Lames de rechange					
EZS2TK		150		0,41	

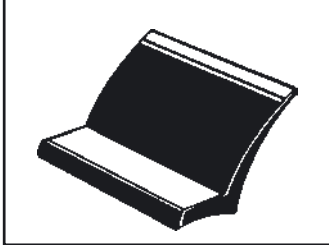

TATCH A CLEAT



Schraubstollen und
Führungsprofile

Mechanical Belt
Cleats and Guides

Profils à vis et de
guidage

	Hinweis: Weitere Informationen finden Sie in unserer Broschüre TAC 100.	Notice: For further Information see our Brochure TAC 100.	Renvoi: Pour d'autres informations veuillez consulter notre brochure TAC 100.			
Tatch-A-Cleat	Zusammensetzung Compound Composition	Min. Trommel-Ø Min. Pulley-Ø Ø tambour mini mm	Temperatur- einsatzbereich Temperature Service Range Température Rayon d'action	Abriebbeständigkeit Abrasion Resistance Résistance à l'abrasion	Ölbeständigkeit Oil Resistance Résistance à l'huile	Säurebeständigkeit Acid Resistance Résistance aux acides
L	Weiß/Schwarz Nitril - FDA White/Black Nitril - FDA blanc/noir nitril - FDA	50	-40° bis / up to / jusqu'à + 110° C	+	++	+
EC	Schwarz EPDM Black EPDM noir EPDM	EC1-3: 75 EC4: 100 EC6: 150	-55° bis / up to / jusqu'à + 150° C	++	N/A	++
HD	Schwarz SBR Black SBR noir SBR	75	-40° bis / up to / jusqu'à + 80° C	++	N/A	0
LUG/PEG	Tan Isopren FDA Tan Isoprene FDA tan isoprène FDA	80	-40° bis / up to / jusqu'à + 80° C	++	N/A	+
GUIDE	Schwarz Neopren Black Neoprene noir neoprène	A: 100 B: 150 C: 200	-40° bis / up to / jusqu'à + 110° C	+	+	+

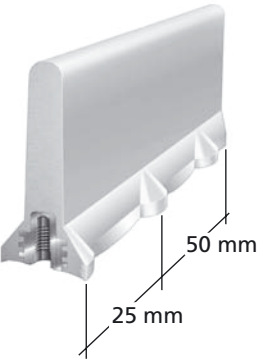
HD Profile Cleats Profils		Bestell-Nr. Order-No. No. de Réf.	Höhe Height Hauteur mm	Inhalt Content Contenu	Gewicht Weight Poids kg
	Schwarz, verzinkte Schrauben Black, plated Fasteners Noir, vis galvanisées	HD-1	25	10X610 mm	5,22
	Schwarz, rostfreie Schrauben Black, stainless Fasteners Noir, vis inoxydables	HD-2	50	5X610 mm	4,30
		HD-1S	25	10X610 mm	5,35
		HD-2S	50	5X610 mm	4,30
Extra Schrauben und Unterlegscheiben Extra Bolts and Washers Vis et rondelles supplémentaires	verzinkt, plated, galvanisées	HD1-F	25	123	1,24
		HD1-1/4-F	32,5	123	1,50
	rostfrei, stainless, inoxydables	HD1-FS	25	123	1,24
		HD2-1/4-FS	32,5	123	1,50
EC Profile Cleats Profils	Schwarz, verzinkte Schrauben Black, plated Fasteners Noir, vis galvanisées	EC1-1/4	32	5X1220 mm	5,67
		EC2	51		7,03
		EC3	76		9,98
		EC4	102		14,97
		EC6	152	2X1220 mm	12,84
Extra Schrauben Extra Bolts Vis supplémentaires	verzinkt, plated, galvanisées	ECF		61	1,27
		EC4F		61	1,50
		EC6F		33	0,91
	rostfrei, stainless, inoxydables	ECFS		61	1,32

		Bestell-Nr. Order-No. No. de réf.	Höhe Height Hauteur mm	Inhalt Content Contenu	Gewicht Weight Poids kg			
 <p>Profile Cleats Profils</p>	Schwarz, verzinkte Schrauben Black, plated Fasteners Noir, vis galvanisées	L5/8-B L1-B L1-1/2-B L2-B L3-B	16 25 38 54 76	10X610 mm	3,31 4,22 5,08 6,35 8,31			
	Schwarz, rostfreie Schrauben Black, stainless Fasteners Noir, vis inoxydables	L5/8-BS L1-BS L1-1/2-BS L2-BS L3-BS	16 25 38 54 76	10X610 mm	3,31 4,22 5,08 6,35 8,31			
	Weiß, verzinkte Schrauben White, plated Fasteners Blanc, vis galvanisées	L5/8-W L1-W L1-1/2-W L2-W L3-W	16 25 38 54 76	10X610 mm	3,31 4,22 5,58 6,58 8,75			
	Weiß, rostfreie Schrauben White, stainless Fasteners Blanc, vis inoxydables	L5/8-WS L1-WS L1-1/2-WS L2-WS L3-WS	16 25 38 54 76	10X610 mm	3,31 4,22 5,58 6,58 8,75			
	Extra Schrauben und Unterlegscheiben für L/LUG/PEG Extra Bolts and Washers for L/LUG/PEG Vis et rondelles supplémentaires pour L/LUG/PEG	Bandstärkenbereich Belt Thickness Range Épaisseur de bande L1/2-F/FS -8 mm L5/8-F/FS 7-11 mm L3/4-F/FS >11 mm	verzinkt / plated / galvanisées L1/2-F L5/8-F L3/4-F	12 16 19	123 123 123	0,45 0,45 0,59		
			rostfrei / stainless / inoxydables L1/2-FS L5/8-FS L3/4-FS	12 16 19	123 123 123	0,45 0,45 0,59		
	 <p>LUG Profile Cleats Profils</p> <p>PEG Profile Cleats Profils</p>		LG1-1/2-C LG-2-C PG2 PG3	38 51 51 76	100 100 100 100	3,00 3,21 1,95 3,13		
		 <p>GUIDE Profile / Cleats Profils</p>	Schwarz, verzinkte Schrauben Black, plated Fasteners Noir, vis galvanisées	A10 B10 C10	10X200 mm	13X10 16X12 26X16	0,45 0,59 1,49	
			Schwarz, rostfreie Schrauben Black, stainless Fasteners Noir, vis inoxydables	A10S B10S C10S	10X200 mm	13X10 16X12 26X16	0,45 0,59 1,49	
			Extra Unterlegscheiben Extra Washers Rondelles supplémentaires	verzinkt, plated, galvanisées Rostfrei / Stainless / Inoxydable verzinkt, plated, galvanisées	CW1024 CWS1024 CW25/100 CWS25/100	L/LUG/PEG L/LUG/PEG HD/EC HD/EC	100 100 100 100	0,20 0,20 0,40 0,40

ANKER-FLEXCO GmbH
Leidringer Straße 40 - 42
D-72348 Rosenfeld

Telefon +49-74 28 - 94 06-0
Telefax +49-74 28 - 94 06-260
e-mail: info@anker-flexco.de
Internet: www.anker-flexco.de

**ANKER
FLEXCO**

TRANSPORTBAND-VERBINDUNGSSYSTEME
CONVEYOR BELT FASTENING SYSTEMS
SYSTÈMES D'AGRAFAGE POUR BANDES TRANSPORTEUSES